

R/A RECEPTACLE MALE
PRINTED CIRCUIT

R197.160.-00

Series : **SMB**
CARLOCK

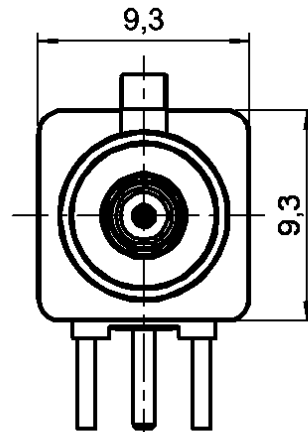
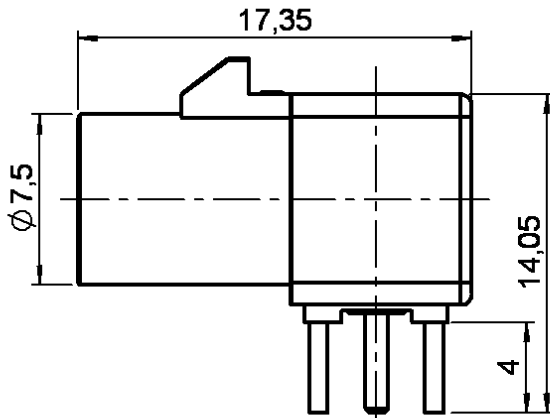

FOR CODING
SEE PAGE 3

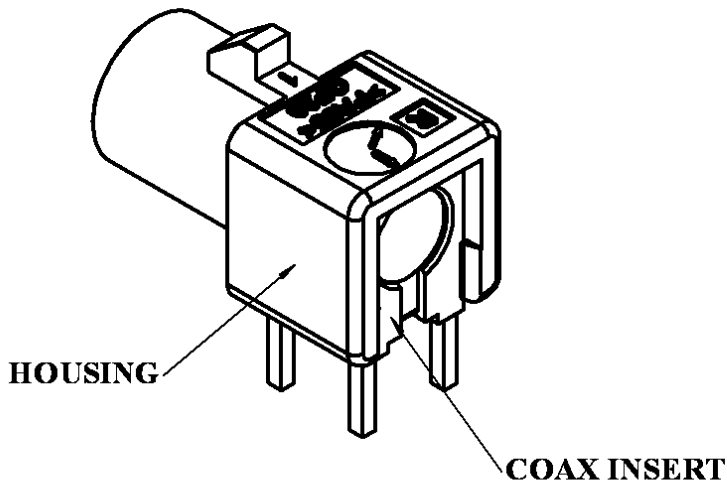

PANEL CUT OUT

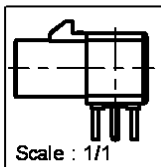
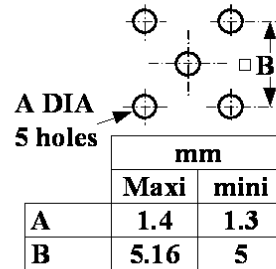

All dimensions are in mm.



COMPONENTS	MATERIALS	PLATINGS (µm)
BODY	BRASS	NICKEL 2
CENTER CONTACT	BRASS	GOLD 0.5 OVER NICKEL 2
OUTER CONTACT		
INSULATOR	PTFE	
GASKET		
OTHERS PARTS		
HOUSING	PA 6.6 30% GF (Polyamide)-	-
-		-

Issue : 0205 A

In the effort to improve our products, we reserve the right to make changes judged to be necessary.



R/A RECEPTACLE MALE

R197.160.-00

PRINTED CIRCUIT

Series : **SMB**
CARLOCK

PACKAGING

SPECIFICATION

Standard	Unit	Other
100	'W' option	Contact us

-

ELECTRICAL CHARACTERISTICS

ENVIRONMENTAL

Impedance		50 Ω
Frequency		0-4 GHz
VSWR	1.2* +	0.000 x F(GHz) Maxi
Insertion loss		0.25 √F(GHz) dB Maxi
RF leakage	- (- F(GHz)) dB Maxi
Voltage rating		335 Veff Maxi
Dielectric withstanding voltage		1000 Veff mini
Insulation resistance		1000 MΩ mini

Operating temperature	-40/+110 ° C
Hermetic seal	NA Atm.cm3/s
Panel leakage	NA

OTHERS CHARACTERISTICS

Assembly instruction

Others :

* Coaxial Transmission Line Only

Use a actived flux for PCB legs solder

MECHANICAL CHARACTERISTICS

Center contact retention		
Axial force – Mating end	10	N mini
Axial force – Opposite end	10	N mini
Torque	NA	N.cm mini

Recommended torque		
Mating	NA	N.cm
Panel nut	NA	N.cm

Mating life	100	Cycles mini
Weight	3.417	g

Issue : 0205 A

In the effort to improve our products, we reserve the right to make changes judged to be necessary.



R/A RECEPTACLE MALE

R197.160.-00

PRINTED CIRCUIT

Series : SMB
CARLOCK

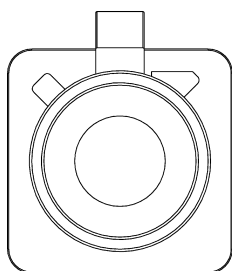

CODING A
COLOR BLACK
RAL 9005

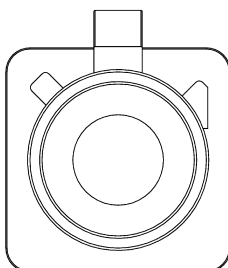

CODING B
COLOR WHITE
RAL 9003

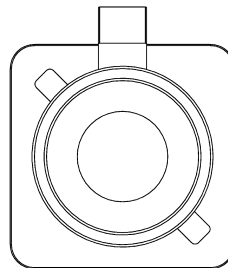

CODING C
COLOR BLUE
RAL 5005

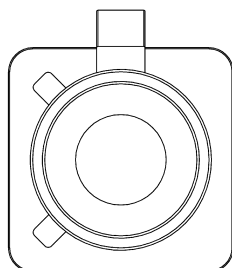

CODING D
COLOR BORDEAUX
VIOLET
RAL 4004

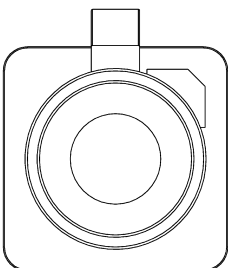

CODING E
COLOR GREEN
RAL 6002

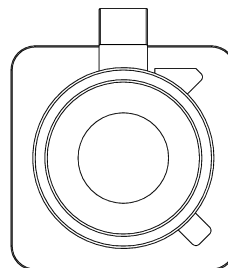

CODING F
COLOR BROWN
RAL 8011

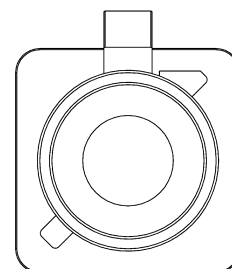

CODING G
COLOR GREY
RAL7031

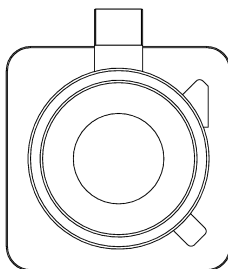

CODING H
COLOR VIOLET
RAL 4003

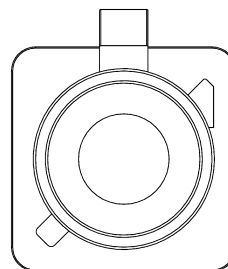

CODING I
COLOR BEIGE
RAL 1001

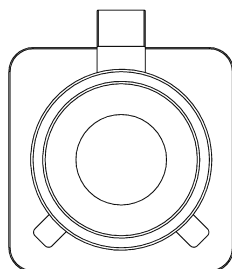

CODING K
COLOR CURRY
RAL 1027

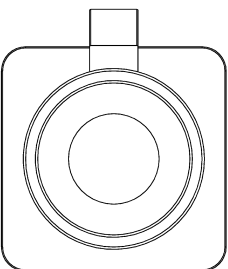

CODING Z
COLOR WATER BLUE
RAL 5021

UL CLASSIFICATION
UL 94V-2

*According to FAKRA specifications

-To obtain the complete P/N please fill in the blank " _ " with the coding letter

Issue : 0205 A

In the effort to improve our products, we reserve the right to make changes judged to be necessary.

